

Motorcycle Shed Assembly Manual

Step-by-step instructions for assembling a bomber shed motorcycle shelter



b  **mber sheds**

www.bombersheds.co.uk



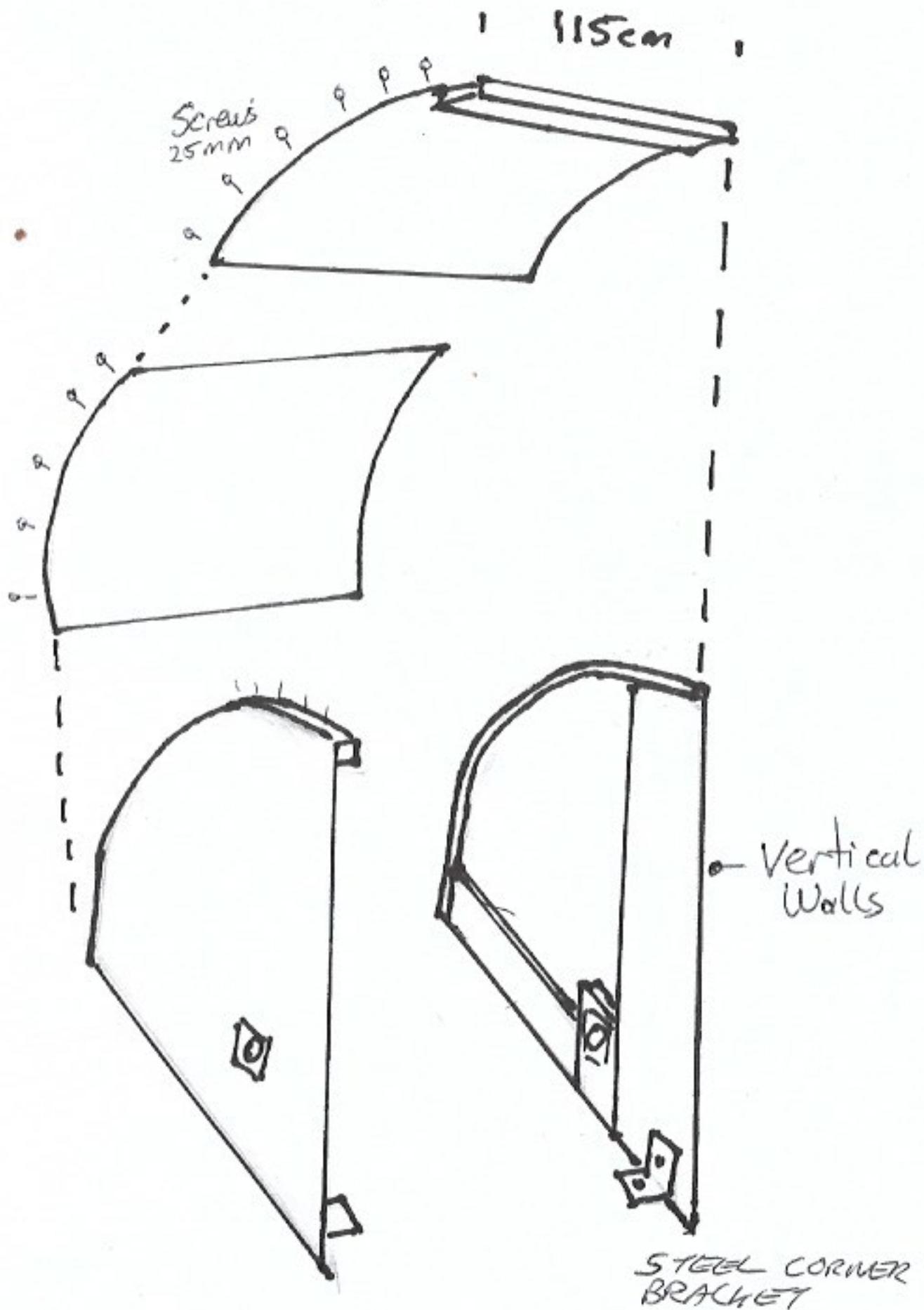

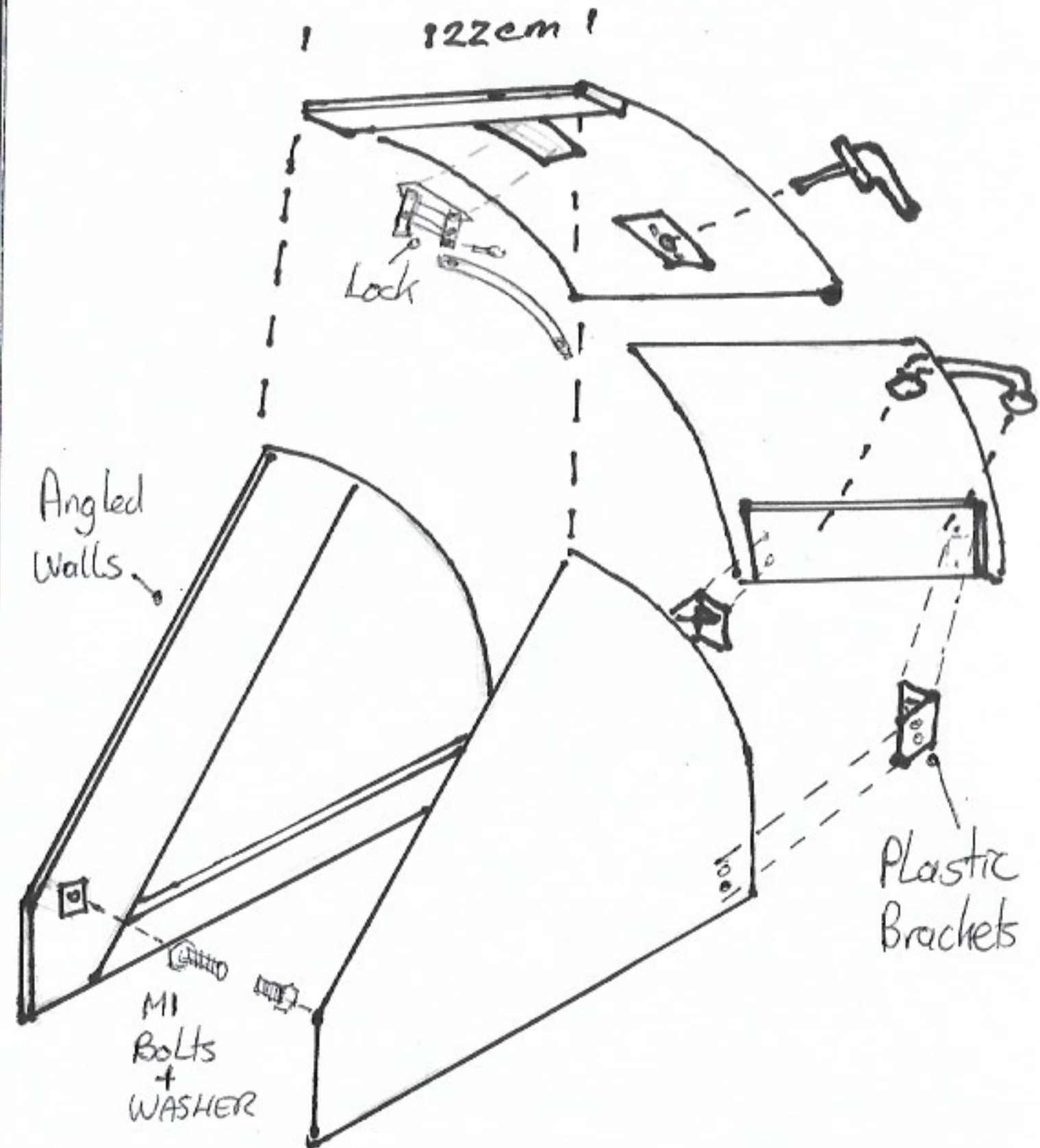

Rear Shell



Door front shell

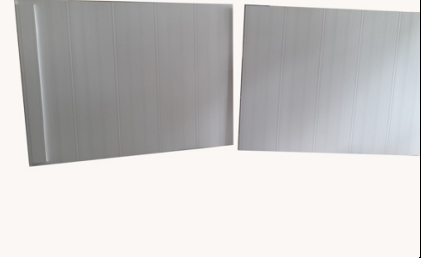







Bomber Shed Instructions

Instructions		
		
<p>1.) Front door wall</p>	<p>2.)Rear shell wall</p>	<p>3.)Front Door Roofs</p>
		
<p>4.) Rear Shell Roofs</p>	<p>5.) Fit front door roof panels on front walls starting from top as in picture. Screws 20mm from side in channels.</p>	<p>6.)</p>
		
<p>7.</p>	<p>8. Fit corner arches with double sided tape pieces.</p>	<p>9.Remove plate and fit pivot bolt.</p>

Bomber Shed Instructions

		
10.	11. Fit grab handle to the front panel on marked circles.	12.
		
13. Fit lock handle	14. Fit handle lever as in pic. Locked position	15.
		
16. Fit rod onto lever with pivot angle.	17. Fit lock mechanism	18.

Bomber Shed Instructions

		
<p>19. Secure rod to mechanism.</p>	<p>20. Locked position up. Rod length can be adjusted by straightening or bending rod more.</p>	<p>21.</p>
		
<p>22. Locked position</p>	<p>23. Unlocked position</p>	<p>24. Fit corner brace/door stoppers in door corners.</p>